

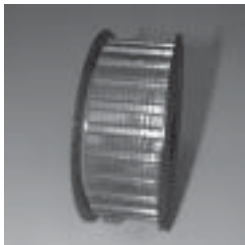

**Power Transmission**

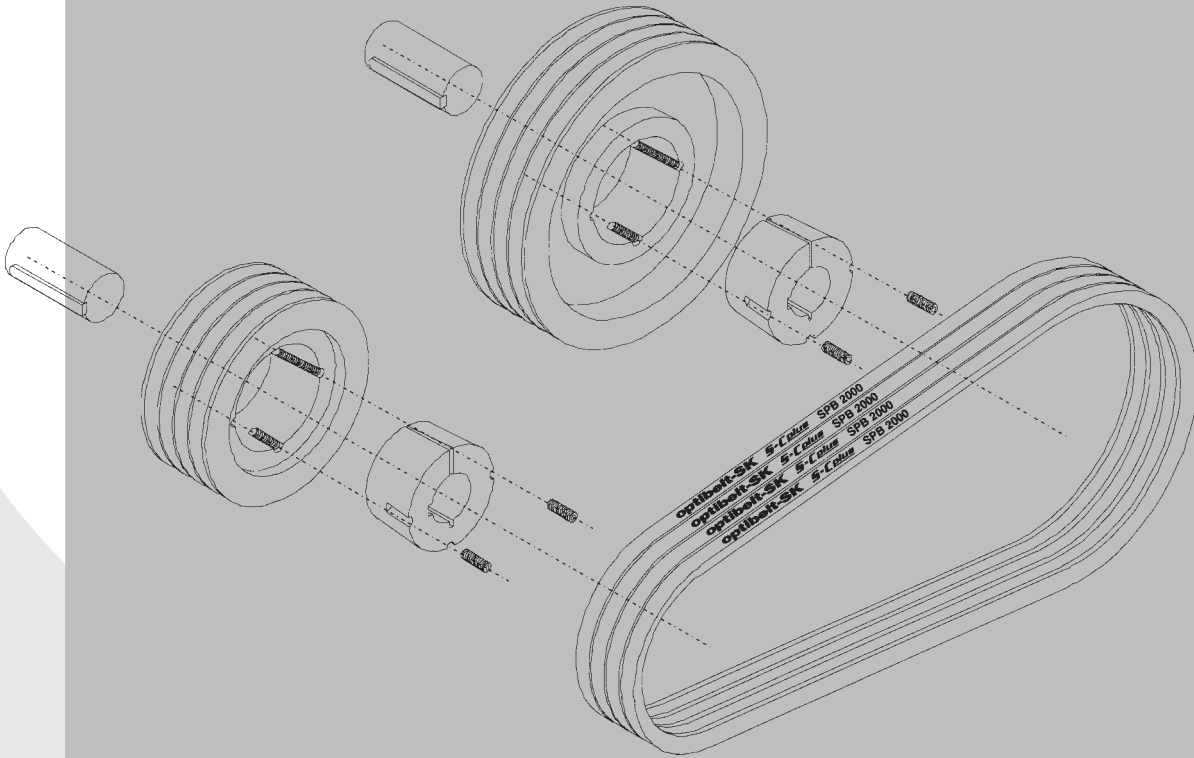

**INSTALLATION AND MAINTENANCE**

**Problem - Cause - Remedy**

# Installation and Maintenance Instructions

**Safety:** Before the beginning of any maintenance work, make sure that all machine components are in a safety position and that they cannot be changed during maintenance work. The safety instructions of the machine manufacturers must be observed.

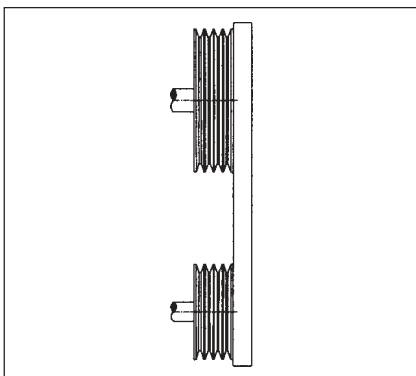
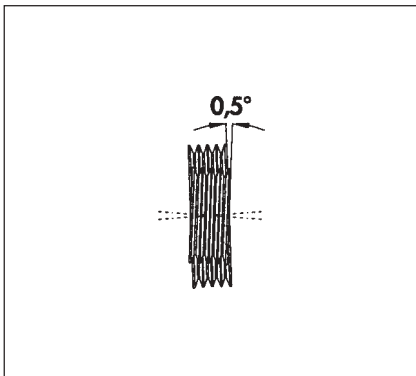
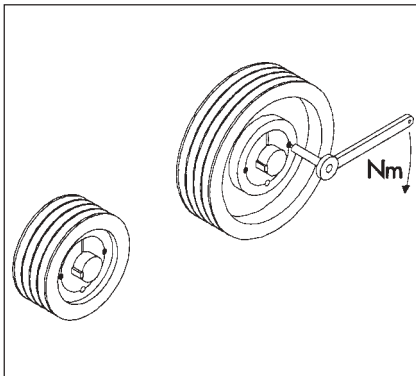
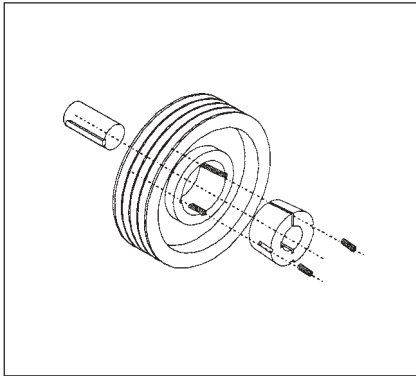

## optibelt *KS* V-grooved pulleys mit taper bush

The V-grooved pulleys are to be checked for damages and correct execution before the initial installation.

### Taper bushes, tightening torques for screws

Size	Key width	Number of screws	Tightening torque (Nm)
TB 1008, 1108	3	2	5,7
TB 1210, 1215, 1310, 1610, 1615	5	2	20,0
TB 2012	6	2	31,0
TB 2517	6	2	49,0
TB 3020, 3030	8	2	92,0
TB 3525, 3535	10	3	115,0
TB 4040	12	3	172,0
TB 4545	14	3	195,0
TB 5050	14	3	275,0

### Horizontal alignment of shafts

Motor and machine shaft may have to be aligned with a machine spirit level.

#### Note!

Maximum shaft deviation 0,5°

### Vertical alignment of V-grooved pulleys

The alignment of the V-grooved pulleys is to be checked before and after the tightening of the taper bushes by means of a guide rail.

#### Note!

Check whether the pulley face width of the V-grooved pulleys is evenly dimensioned. A possible existing deviation of the pulley face width has to be taken into consideration correspondingly. With a symmetrical pulley face construction the distance to the guide rail to the smaller face width is half of the deviation.

# Installation and Maintenance Instructions

**Note:** These installation and maintenance instructions apply with appropriate modifications also to Optibelt timing belts and ribbed belts. For details see corresponding technical manuals.

## Initial Installation

V-belts should be installed without using force. Installation using screwdrivers, crow-bars etc. causes internal and external damage to the belt. V-belts installed by force may in some instances only work for a few days. Correct installation of the belt saves time and money.

If installation allowance is limited, it may be necessary to fit the belts to the pulleys and then attach them to the shafts.

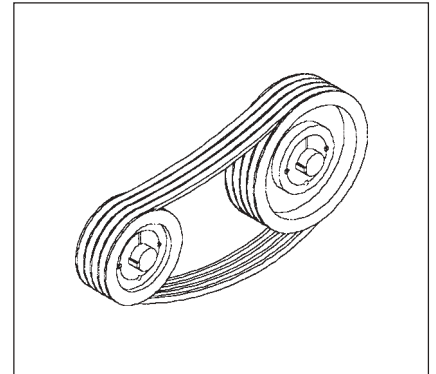

## Belt tension

Belt tension values should follow Optibelt recommendations. Align the motor parallel up to the stated belt tension. Carry out several belt revolutions and check static belt tension again. Experience has shown that belt tension needs to be checked again after 0.5 to 4 hours and then corrected, if necessary. For further information on tensioning gauges and how to use them see page 5.

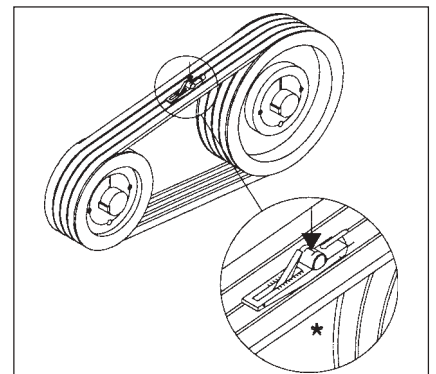

## Permissible shaft misalignment

After tightening to the correct initial installation tension, the distances  $X_1$  and  $X_2$  between the two pulleys  $d_{d1}$  and  $d_{d2}$  and the guide rail at shaft level should be measured. The distances measured should ideally fall below the maximum permissible values for the distance  $X$  from the table, depending on the pulley diameters  $d_d$ . According to pulley diameter, the interim values for  $X$  are to be interpolated.

Pulley diameter $d_{d1}, d_{d2}$	Maximum permissible centre distance $X_1, X_2$
112 mm	0,5 mm
224 mm	1,0 mm
450 mm	2,0 mm
630 mm	3,0 mm
900 mm	4,0 mm
1100 mm	5,0 mm
1400 mm	6,0 mm
1600 mm	7,0 mm

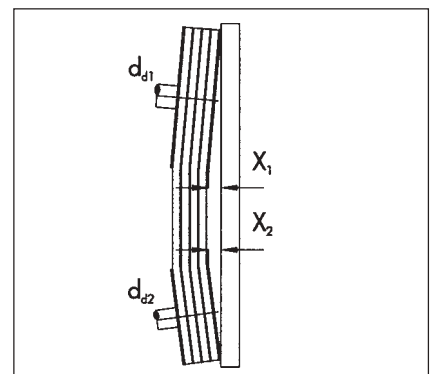

## Inspections

We recommend that the drive should be inspected regularly, e.g. after 3 to 6 months. V-grooved pulleys should be checked for wear and tear and overall condition. As an aid, you are advised to use the Optibelt section and pulley groove template.

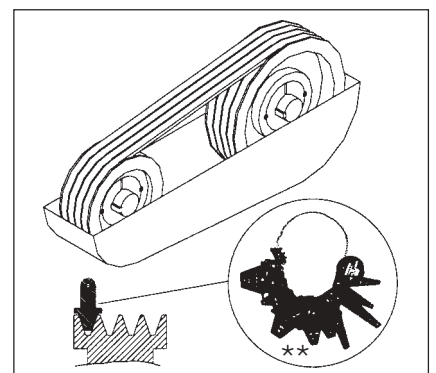

\*\* section and pulley groove template

# Installation and Maintenance Instructions

## V-grooved pulleys with taper bushes

### Installation

1. All shiny surfaces such as bore and end envelope of cone of the taper bush as well as conical bore of the pulley should be clean and free of grease. Fit the taper bush into the hub and align with all holes. The half-tapped holes should be aligned with the half plain bored holes.
2. Stud screws (TB 1008-3030) or fillister head screws (TB 3525 to 5050) should be slightly oiled and screwed in but not fully tightened.
3. Clean and degrease the shaft. Position the pulley with the taper bush in the correct place on the shaft. See information about V-grooved pulley alignment.
4. If a key is used, place this first into the keyway of the shaft. Make sure there is a tolerance between the key and the bore keyway.



5. Using a socket wrench according to DIN 911, tighten the stud screws or the fillister socket screws evenly to the torque values given in the table below.
6. After a short run (0.5 to 1 hour), check the tightening torque values of the screws and tighten if necessary.
7. Fill the empty bush bores with grease to prevent foreign matter from entering.



### Installation

Size  
TB 1008-3030

Size  
TB 3525-5050

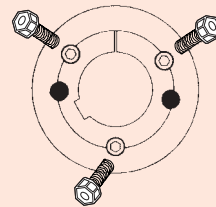
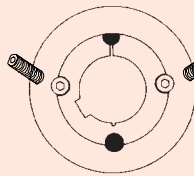

### When V-grooved pulleys with taper bush are being replaced, the following points should be noted:

1. Loosen all screws. According to bush size, completely unscrew one or two screws, grease them and screw them into the proof test bores.
2. Tighten the screw or screws evenly until the bush comes out of the hub and the pulley can move freely on the shaft.
3. Remove pulley with bush from the shaft.



### Belt tension

Size  
TB 1008-3030

Size  
TB 3525-5050

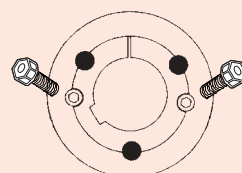
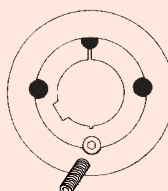

# Belt tension optibelt Tension Testers

## Optibelt Optikrik Tension gauges

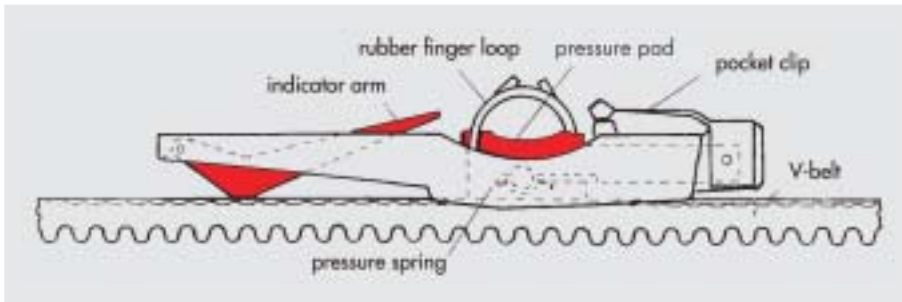

This gauge serves as a simplified method of belt tension.

This simplified tensioning method should be used for example when technical data are not known and, therefore, the optimum tension cannot be calculated. The diameter of the smaller driver pulley and the belt section have to be determined only.

The Optibelt tension gauge is used to read off the belt tension. By reducing or increasing the belt tension the desired value can be obtained.

For different tension values, Optikrik 0, I, II, III with corresponding measurement ranges are available.

### Instructions for use

1. The gauge is placed in the middle between the two pulleys on the back of the belt, in the case of belt sets ideally on the centre belt. (First, press the indicator arm fully onto the scale)
2. Lay the gauge loosely on the belt to be measured and press a finger slowly on to the pressure surface.
3. Try not to touch the gauge with more than one finger during the measuring process.
4. Once you hear or feel a definite click, immediately release pressure and the indicator arm will remain in the measured position.
5. Carefully lift the gauge without moving the indicator arm. Read off the belt tension (see diagram). Read off the measurement at the exact point where the top surface of the indicator arm crosses the scale.
6. Reduce or increase the belt tension according to the measurement result until it is within the desired tension level.

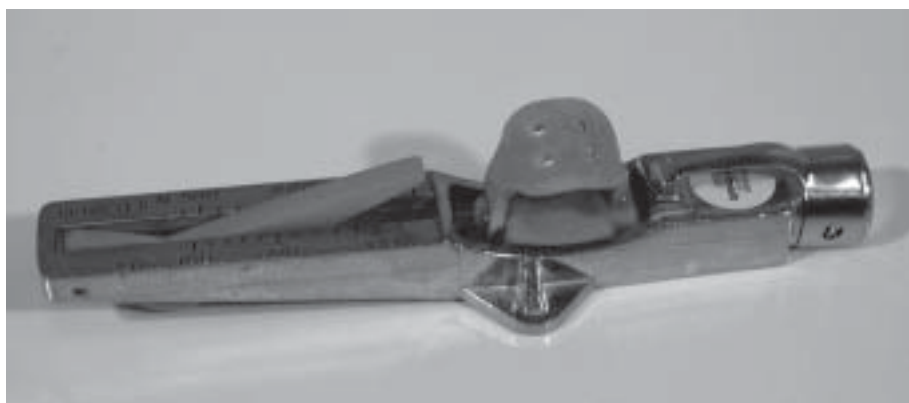

## optibelt *TT2* Frequency Tension Tester



This optibelt *TT2* Frequency Tension Tester is used for tension checking of drive belts by means of frequency measurement. Measurements are in Hertz (Hz). When belt parameters are entered, tension is indicated in Newton (N).

### Advantages of the tester:

- Non-contact, repetition sure measurement
- Large measurement range from 10 - 600 Hz.
- High accuracy of measurement
- Quality assessment of the measurement results
- Storage in a data base
- Easy to use
- Universal measuring head for comfortable measuring
- Data communication via PC

# Belt tension

## optibelt V-belts

Section	Diameter of the small pulley $d_e$  [mm]	Static belt tension [N]					
		RED POWER II		Standard wrapped		SUPER TX M=S	
		Initial installation up new belts	New installation existing belts	Initial installation	Operation after start-up	Initial installation	Operation after start-up
<b>SPZ; 3V/9N;</b> <b>XPZ; 3VX/9NX</b>	$\leq 71$	250	200	200	150	250	200
	$> 71 \leq 90$	300	250	250	200	300	250
	$> 90 \leq 125$	400	300	350	250	400	300
	$> 125^*$						
<b>SPA;</b> <b>XPA</b>	$\leq 100$	400	300	350	250	400	300
	$> 100 \leq 140$	500	400	400	300	500	400
	$> 140 \leq 200$	600	450	500	400	600	450
	$> 200^*$						
<b>SPB; 5V/15N;</b> <b>XPB; 5VX/15NX</b>	$\leq 160$	700	550	650	500	700	550
	$> 160 \leq 224$	850	650	700	550	850	650
	$> 224 \leq 355$	1000	800	900	700	1000	800
	$> 355^*$						
<b>SPC;</b> <b>XPC</b>	$\leq 250$	1400	1100	1000	800	1400	1100
	$> 250 \leq 355$	1600	1200	1400	1100	1600	1200
	$> 355 \leq 560$	1900	1500	1800	1400	1900	1500
	$> 560^*$						
<b>Z/10;</b> <b>ZX/X10</b>	$\leq 50$			90	70	120	90
	$> 50 \leq 71$			120	90	140	110
	$> 71 \leq 100$	-	-	140	110	160	130
	$> 100^*$						
<b>A/13;</b> <b>AX/X13</b>	$\leq 80$			150	110	200	150
	$> 80 \leq 100$			200	150	250	200
	$> 100 \leq 132$			300	250	400	300
	$> 132^*$						
<b>B/17;</b> <b>BX/X17</b>	$\leq 125$			300	250	450	350
	$> 125 \leq 160$			400	300	500	400
	$> 160 \leq 200$			500	400	600	450
	$> 200^*$						
<b>C/22;</b> <b>CX/X22</b>	$\leq 200$			700	500	800	600
	$> 200 \leq 250$			800	600	900	700
	$> 250 \leq 355$			900	700	1000	800
	$> 355^*$						

\* Tension values for these pulleys must be calculated.

### Tension gauges:

Optikrik 0	Range:	70 – 150 N
Optikrik I	Range:	150 – 600 N
Optikrik II	Range:	500 – 1400 N
Optikrik III	Range:	1300 – 3100 N

The tension values (static belt tension) shown are guideline values when accurate drive data is not available. They are calculated for maximum power transmission capability per belt.

### Calculation Basis

Wedge belts	belt speed $v = 5$ bis 42 m/s
Classical V-belts	belt speed $v = 5$ bis 30 m/s

### Procedure

1. Look for the applied section in the column.
2. For this purpose take the smallest pulley diameter in the drive system.
3. You can read the corresponding static tension from the table.
4. Check static tension with the tension gauge as described.

### Example

- |   |        |
|---|--------|
| 1. Optibelt V-belt standard section                   | SPZ    |
| 2. Smallest pulley diameter in drive                  | 100 mm |
| 3. Static belt tension – tension initial installation | 350 N  |
| 4. Static belt tension – tension in operation         | 250 N  |



# Belt tension

## optibelt Ribbed belts

Section	Diameter of the small pulley $d_e$ [mm]	Static tension $T_{max}$ [N]									
		Initial intallation		Operation after start-up		Initial intallation		Operation after start-up		Initial intallation	
PH	$\leq 25$	4 PH		8 PH		12 PH		16 PH		20 PH	
	$> 25 \leq 71$	90	70	150	130	250	200	300	250	400	300
	$> 71^*$	110	90	200	150	300	250	350	300	450	350
PJ	$\leq 40$	4 PJ		8 PJ		12 PJ		16 PJ		24 PJ	
	$> 40 \leq 80$	200	150	350	300	500	400	700	550	1000	800
	$> 80 \leq 132$	200	150	400	350	600	500	800	650	1200	1000
$> 132^*$	250	200	450	350	700	550	900	700	1300	1000	
PK	$\leq 63$	4 PK		8 PK		10 PK		12 PK		16 PK	
	$> 63 \leq 100$	300	250	600	450	700	600	900	700	1200	900
	$> 100 \leq 140$	400	300	800	600	1000	700	1200	900	1500	1200
$> 140^*$	450	350	900	700	1100	800	1300	1000	1600	1300	
PL	$\leq 90$	6 PL		8 PL		10 PL		12 PL		16 PL	
	$> 90 \leq 140$	800	600	1000	800	1300	1000	1500	1200	1900	1500
	$> 140 \leq 200$	1000	700	1300	1000	1600	1300	1900	1500	2500	1900
$> 200^*$	1100	800	1400	1100	1900	1400	2100	1600	2800	2100	

### Procedure

1. Look for the applied section in the column.
2. For this purpose take the smallest pulley diameter in the drive system.
3. You can read the corresponding static tension in the table.
4. Check the static tension with the tension gauge as described.

### Example

- |  |        |
|--|--------|
| 1. Optibelt RB ribbed belt section                   | 4 PJ   |
| 2. Smallest pulley diameter in drive $d_b$           | 100 mm |
| 3. Static belt tension – tension first installation. | 250 N  |
| 4. Static belt tension – tension after start-up      | 200 N  |



# Belt tension

## optibelt Timing belts

For tension values of Optibelt timing belts please consult the corresponding technical manuals or contact our engineers from the applications engineering dept.

# Problems – Causes – Remedies

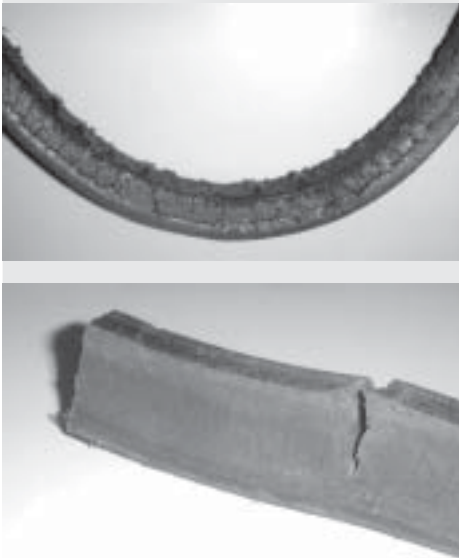

## V-belts

Problem	Possible causes	Remedies
<p><b>Belt breaks after short running period (Belt torn)</b></p> 	<p>Forceful mounting, therefore, damaging the tension cord</p> <p>Drive blocked</p> <p>Ingress of foreign matter during operation</p> <p>Drive underdimensioned, insufficient number of belts</p>	<p>Apply unforced mounting according to instructions</p> <p>Remove the cause</p> <p>Fit a guard</p> <p>Check drive conditions and remachine</p>
<p><b>Excessive wear on belt edges</b></p> 	<p>Tension too low</p> <p>Starting torque too high</p> <p>Worn pulley grooves</p> <p>Wrong belt/groove section</p> <p>Wrong groove angle</p> <p>Pulleys do not align</p> <p>Small pulley diameter below recommended minimum</p> <p>Belt slips or catches on protruding parts</p>	<p>Check tension and retension</p> <p>Check drive conditions and remachine</p> <p>Replace pulleys</p> <p>Adjust belt and groove sections</p> <p>Remachine or replace pulleys</p> <p>Align pulleys</p> <p>Increase pulley diameter (new drive design), Use Optibelt special execution or Optibelt Super TX = MS</p> <p>Remove protrusions or realign drive</p>
<p><b>Cuts and splits at the base of the belt (brittleness)</b></p> 	<p>Outside idler pulley in use the arrangement and diameter of which does not comply with our recommendations</p> <p>Abnormal belt slip</p> <p>Pulley diameter too small</p> <p>Ambient temperature too high</p> <p>Ambient temperature too low</p> <p>Chemical influences</p>	<p>Note Optibelt recommendations e.g. increase diameter. Increase size of existing idler. Use Optibelt Red Power II or Optibelt special execution</p> <p>Retension drive according to installation instructions. Check drive conditions and redesign, if necessary Redesign using minimum pulley diameters.</p> <p>Use Optibelt special execution or Optibelt Super TX M=S.</p> <p>Ensure good ventilation, protect belts from direct heat. Use Optibelt XHR special execution (extra heat-resistant) or use Optibelt Super TX M=S or belt with aramid cord construction.</p> <p>Warm area surrounding drive and belt before use. Use Optibelt special execution.</p> <p>Protect drive from contamination. Use Optibelt special execution.</p>



# Problems – Causes – Remedies

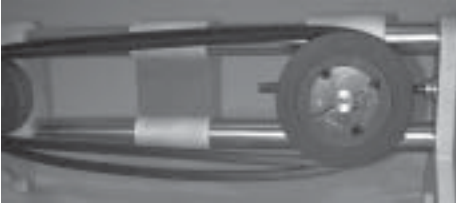

## V-belts

Problem	Possible causes	Remedies
<b>Belt swelling or softening</b> 	Contamination by oil, grease, chemicals	Protect drive from contamination Use raw edge Super TX M=S or special execution "05". Clean pulley grooves with petrol or alcohol before using new belts!
<b>Belts turn over</b> 	Wrong belt / groove section Pulleys do not align Pulley grooves severely worn Tension too low Excessive vibrations Foreign matter in pulley grooves	Realign belt and groove section correctly Realign pulleys Replace pulleys Retension drive Use inside idler pulley on drive slack side or Optibelt KB Kraftbands Remove foreign matter and protect drive
<b>Severe belt vibration</b>	Drive overloaded (underdimensioned) Centre distance far larger than recommendations High shock loads Belt tension too low Unbalanced V-grooved pulleys	Check drive conditions and redesign Reduce shaft centre distance; use inside idler pulley on the drive slack side. Use Optibelt Kraftbands Use Optibelt Kraftbands. Use inside idler pulley Use Optibelt special execution. Correct tension Balance pulleys
<b>Belts cannot be retensioned</b> 	Allowance of centre distance too low Excessive belt stretching, due to underdimensioned (and overloaded) drive Wrong belt length	Modify drive to allow more take-up according to Optibelt recommendations Recalculate drive design and modify Use shorter belt length.
<b>Excessive running noise</b>	Poor drive alignment Belt tension too low Drive overloaded	Realign pulleys Check tension and retension Check drive conditions and redesign if necessary
<b>Uneven belt stretching</b> 	Worn or badly machined pulley grooves Used belts mixed with new belts on the same drive Belts from different manufacturers used on the same drive	Replace pulleys Fit completely new set of belts Use belts in sets from one manufacturer only - Optibelt S=C plus, Optibelt Super TX M=S, Optibelt Red Power II.

If further problems arise, contact our engineers from the applications engineering dept. Detailed technical data are necessary for specific assistance.

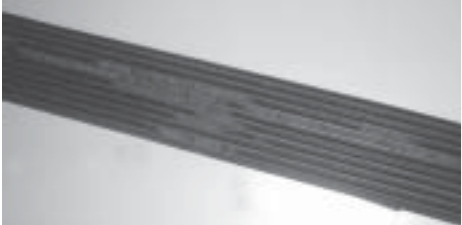

# Problems – Causes – Remedies

## Ribbed belts

Problem	Possible causes	Remedies
<p><b>Unusual wear and tear of ribs</b></p> 	<p>Tension too low</p> <p>Ingress of foreign matter during operation</p> <p>Pulleys do not align</p> <p>Pulleys defective</p> <p>Wrong rib belt /pulley section</p>	<p>Correct tension</p> <p>Fit a guard</p> <p>Align pulleys</p> <p>Remachine or replace pulleys</p> <p>Align rib and pulley section</p>
<p><b>Break of ribbed belts after short running time (belts torn)</b></p> 	<p>Ribbed belt slips or catches on protruding parts</p> <p>Drive blocked</p> <p>Drive overloaded</p> <p>Effects of oil, grease, chemicals</p>	<p>Remove protruding parts Realign drive</p> <p>Remove cause</p> <p>Check drive conditions and redesign</p> <p>Protect drive from environmental influences</p>
<p><b>Cuts and splits in the ribs (brittleness)</b></p> 	<p>Effects of an outside idler pulley the arrangement and diameter of which does not comply with our recommendations</p> <p>Pulley diameter too small</p> <p>Ambient temperature too high</p> <p>Ambient temperature too low</p> <p>Abnormal belt slip</p> <p>Chemical influences</p>	<p>Comply with Optibelt recommendations e.g. increase diameter Use an inside idler pulley on the drive slack side</p> <p>Ensure minimum pulley diameter</p> <p>Remove source of heat, protect. Improve air ventilation.</p> <p>Warm up ribbed belt before use</p> <p>Retension drive according to installation instructions. Check drive conditions and redesign if necessary.</p> <p>Protect drive.</p>

# Problems – Causes – Remedies





## Ribbed belts

Problem	Possible causes	Remedies
<b>Severe Vibrations</b>	Drive underdimensioned  Shaft centre distance far bigger than recommendations  High shock loads  Tension too low  V-grooved pulleys not balanced	Check drive conditions and modify if necessary  Reduce shaft centre distance. Install idler pulley on drive slack side  Use idler pulley  Correct tension  Balance pulleys
<b>Ribbed belts cannot be retensioned</b> 	Adjustment allowance of shaft centre distance too small  Excessive stretching caused by underdimensioned drive  Incorrect ribbed belt length	Correct range of adjustment according to Optibelt recommendations  Recalculate drive design and modify  Install shorter ribbed belt length
<b>Excessive running noise</b>	Pulleys do not align  Tension too low or too high  Drive overloaded	Align pulleys  Check tension  Check drive conditions and redesign
<b>Ribbed belts swelling and softening</b> 	Effects of oil, fat, chemicals	Protect drive from foreign matter  Clean pulleys with petrol or alcohol before using new ribbed belts.

If further problems arise, contact our engineers from the applications engineering dept. Detailed technical data are necessary for specific assistance.

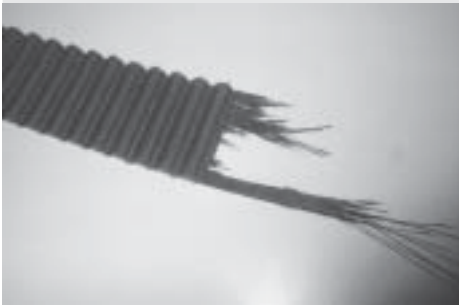

# Problems – Causes – Remedies

## Timing belts

Problem	Possible causes	Remedies
<b>Belt teeth shearing off (belt break)</b> 	Belt kinked before or during installation Overloading Number of engaging teeth too small  Foreign matter in the drive  Tension too high	Do not kink belts Install wider belts or larger pulleys Increase diameter of small pulley or choose wider belts Remove foreign matter and protect drive Correct tension
<b>Severe wear on the tooth edge in use</b> 	Incorrect belt tension Overloading Drive underdimensioned  Tooth pitch selection error Defective timing belt pulley	Correct tension Install wider belts with higher power transmission capability / increase size of timing belt or pulley Check section and replace if necessary Replace timing belt pulleys
<b>Unusual wear of sides of belt</b> 	Incorrect shaft parallelism Defective flanged pulleys Alteration of shaft centre distance	Realign shafts Replace flanged pulleys Reinforce bearings and/or casing
<b>Excessive lateral run-off</b> 	Incorrect shaft parallelism Timing belt pulleys not aligned Shock load pressure when belt tension is too high	Realign shafts Realign pulleys Reduce belt tension

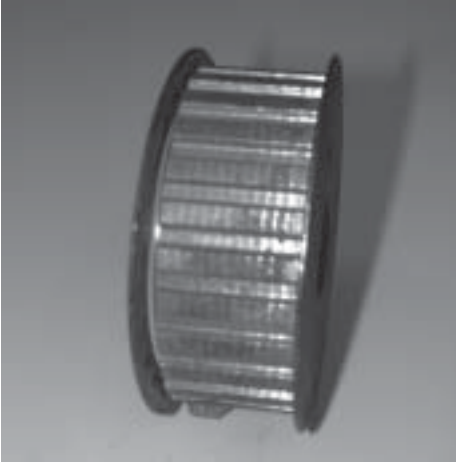

# Problems – Causes – Remedies

## Timing belts

Problem	Possible causes	Remedies
<p><b>Excessive wear at the bottom of the notches</b></p> 	<p>Belt tension too high Drive underdimensioned</p> <p>Defective timing belt pulleys</p>	<p>Reduce tension Increase size of timing belts and/or pulleys Replace timing belt pulleys</p>
<p><b>Tears in longitudinal direction</b></p> 	<p>Defective flanged pulleys Belt runs up to the flanged pulley Effects of foreign matter during operation</p> <p>Cutting error during cutting of sleeve</p>	<p>Replace flanged pulleys Realign pulleys/shafts; correct tension Remove foreign matter Fit protective guard Check cutting adjustment and sleeve / belt guide setting</p>
<p><b>Flanged pulleys coming off</b></p> 	<p>Timing belt pulleys not aligned Very strong lateral pressure of timing belt Incorrect installation of flanged pulleys</p>	<p>Realign timing belt pulleys Realign shafts Install flanged pulleys correctly</p>
<p><b>Excessive running noise</b></p>	<p>Incorrect shaft alignment Belt tension too high Pulley diameters too small Overloading of timing belt</p> <p>Belt width too large at high speed</p>	<p>Realign shafts Reduce tension Increase diameter of pulleys Increase width of belt or tooth engagement Reduce width of belt by selecting larger belt sections</p>

# Problems – Causes – Remedies

## Timing belts

Problem	Possible causes	Remedies
<p><b>Apparent lengthening of belt</b></p> 	<p>Storage too soft</p>	<p>Correct belt tension Increase and secure storage firmness</p>
<p><b>Abnormal wear of timing belt pulleys</b></p>	<p>Unsuitable working material Incorrect engagement of teeth Insufficient hardness of surface</p>	<p>Use harder working materials Replace timing belt pulleys Use harder material or carry out surface hardening</p>
<p><b>Brittleness of top surface</b></p> 	<p>Ambient temperature higher than + 85 °C Incompatible radiation</p>	<p>Choose extra heat resistant quality Protect or install suitable belt quality</p>
<p><b>Tears in the top surface</b></p> 	<p>Ambient temperature below - 30 °C</p>	<p>Install cold resistant belt quality</p>
<p><b>Softening of the top surface</b></p>	<p>Effects of incompatible substances and/or chemicals</p>	<p>Protect or install suitable belt quality</p>

If further problems arise, contact our engineers from the applications engineering dept. Detailed technical data are necessary for specific assistance.



# Problem – Cause – Remedy

## Sources of error

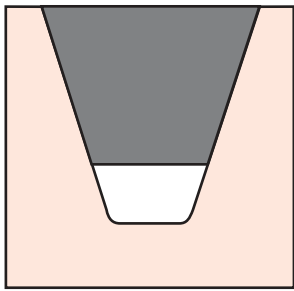

Correct belt arrangement in the V-grooved pulley

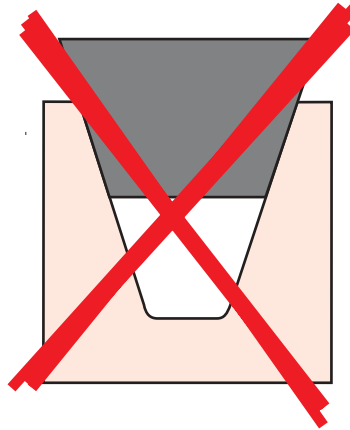

Belt too big/  
pulley groove too small

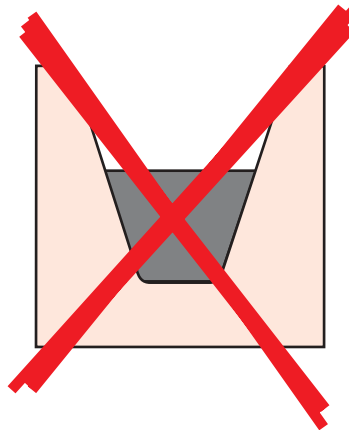

Belt section too small/  
pulley section too big

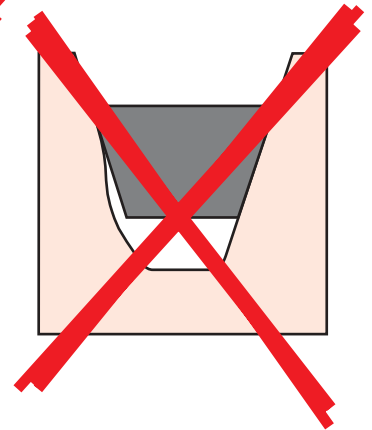

Worn V-grooved pulley

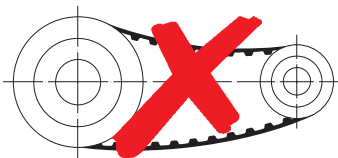

Tension too low

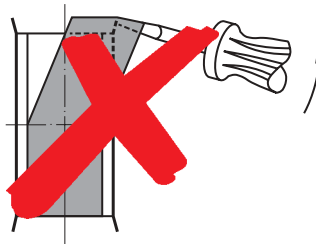

Installation by force

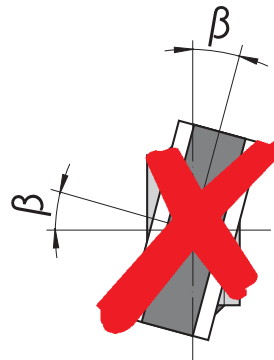

Vertical angle deviation of the shafts

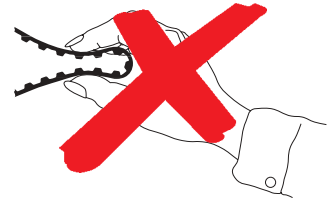

Kinked belt



Aligned pulleys on axially parallel shafts



Axial misalignment of pulleys

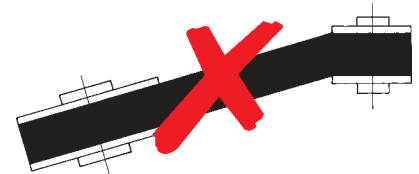

Horizontal angle deviation of the shafts

The Optibelt offer is aimed exclusively at specialist distributors. Optibelt recommends that its products be used exclusively according to the instructions in the Optibelt documentations. Optibelt will not be held responsible if the products are used in any application for which it was not designed or manufactured. Optibelt would also like to point out its General Terms of Business.

# Installation, maintenance and storage

Drives with Optibelt V-belts that have been correctly installed in terms of geometry and performance guarantee high operational safety and maximum durability.

Practice has shown that unsatisfactory service life is often caused by installation and maintenance errors. In order to prevent these, we recommend that you carefully follow the below mentioned installation and maintenance instructions:

## ● Safety

Before the beginning of any maintenance work, make sure that all machine components are in a safety position and that they cannot be changed during maintenance work. The safety instructions of the machine manufacturers must be observed.

## ● Pulleys

The grooves must be produced according to standard and must be clean.

## ● Alignment

Shafts and pulleys must be correctly aligned before installation.

We recommend that the maximum deviation of the pulley alignment should not exceed  $1/2^\circ$ .

## ● Multi-groove drives

V-belts for multi-groove drives must usually be measured in sets. The belt set tolerance according to the valid standard should be noted here. Optibelt S=C plus and Optibelt Super TX M=S V-belts, however, can be combined into sets without measuring.

## ● Installation of the V-belts

Before installation, the shaft centre distance is to be reduced so that the belts can be placed in the grooves without force. Forced installation using crow-bars, screw drivers etc. is not permitted under any circumstances, as this damages - often not visible - the high-quality, low-stretch tension cord or the cover fabric.

## ● Belt tension

After the calculated shaft loading has been obtained, the tension of the belts should be checked. We recommend that you use our Optibelt tension gauges for this purpose. The drive should be observed during the first hours of operation, and experience shows that it will need to be re-tensioned after running for a period from 0.5 to 4 hours under full load. This restores tension to the original level.

## ● Idler pulleys/ guide pulleys

Idler pulleys and guide pulleys are to be avoided. If they have to be used, the recommendations of our manual must be followed.

## ● Maintenance

We recommend regular checks of the V-belt drives. This includes checking the tension and, if necessary, correcting it. If in the case of multi-groove drives one or more V-belts fail, a new V-belt set must be mounted. V-belts from different manufacturers must not be combined to form a belt set. Before mounting new V-belts, the condition of the V-belt pulleys must be checked. Optibelt V-belts do not require any special care. Belt wax and belt spray should not be used.

## ● Storage - General

Correctly stored V-belts maintain their quality and properties over a period of several years (also see DIN 7716). In unfavourable storage conditions and when incorrectly treated, most rubber products change their physical properties. Such changes can be caused for example by the effects of oxygen, ozone, extreme temperatures, light, dampness or solvents.

## ● Store-room

The store-room should be dry and free of dust.

V-belts should not be stored together with chemicals, solvents, fuel, lubricants, acids etc.

## ● Temperature

The recommended storage temperature should be  $+15^\circ\text{C}$  to  $+25^\circ\text{C}$ . Lower temperatures do not generally cause damage to V-belts. However, as they become very stiff as a result of cold, they should be brought up to a temperature of about  $+20^\circ\text{C}$  before operation. This will help to prevent breaks and tears.

Radiators and radiator pipes should be screened. The distance between the radiators and the stored goods must be at least 1 m.

## ● Light

V-belts should be protected from light, especially from direct sunlight and from strong artificial light with a high ultra-violet content (ozone formation), e.g. naked neon tubes. The ideal form of lighting is with normal light bulbs.

## ● Ozone

To counteract the harmful effects of ozone, the store-rooms must not contain any ozone-producing items e.g. fluorescent light sources, mercury vapour lamps, high-voltage electrical equipment etc. Combustion gases and vapours that can cause the production of ozone as a result of photo-chemical processes should be avoided or eliminated.

## ● Dampness

Damp store rooms are unsuitable. Efforts should be made to ensure that no condensation occurs. The relative air humidity should ideally be under 65 %.

## ● Storage

V-belts should be stored without tension, i.e. without pulling, pressure or other deformations, as tension and permanent deformations can lead to formation of cracks.

If V-belts are placed on top of each other, it is advisable not to exceed a stacking height of 300 mm in order to avoid permanent deformations. If for reasons of space the belts are suspended, the diameter of the mandrel should be at least 10 times the height of the belt.

**In the case of optibelt S=C PLUS, RED POWER II and optibelt SUPER TX M=S, there is no need to store in sets as these belts can be combined into sets without measuring.**

## ● Cleaning

Cleaning of dirty V-belts should be done with a glycerine-spirit mixture in the proportion of 1 : 10. Petrol, benzene, turpentine etc. should not be used. Sharp-edged objects, wire brushes, sandpaper etc. should not be used under any circumstances as this can cause mechanical damage to the V-belts.

## Optibelt GmbH

P.O. Box 100132 • D-37669 Hörter/Germany • Tel. +49 (0)52 71-6 21 • Fax +49 (0)52 71-9762 00  
info@optibelt.com • www.optibelt.com